



# STABILISED Telehandlers

P30.10  
P35.11  
P40.12  
P40.13

P40.14  
P40.17  
P50.18 PLUS

 **MERLO**





## Index

Merlo Group.....	3
Panoramic Range.....	4
Merlo Technologies	
• Safety.....	6
• Performance.....	10
• Comfort.....	12
• Efficiency.....	16
Range.....	18
Attachments.....	20
Services.....	20
Technical characteristics.....	21





# Merlo: The technological leader in operating machines

Merlo is an important family-run industrial group founded in Cuneo in 1964 that designs, produces and markets its own products under the "Merlo" and "Treemme" brands.

People and the territory are at the centre of the project; the Merlo Group is committed to respecting the environment and making the work of the operator (and everyone who is passionately dedicated to constantly improving the efficiency and performance of our products) more functional, safe and comfortable.

The product portfolio consists of a complete range of telescopic handlers, both fixed and rotating, DBM self-loading concrete mixers, Treemme municipal and forestry tool carriers and Cingo multi-purpose tracked transporters.

All products in the Merlo range are characterised by innovation, technology and reliability, which have always been distinctive features of the Group and have gained market confidence.



# STABILIZED TELEHANDLER RANGE: **Always first in class**

Since 1987, the launch date of the first telehandler in the world with a lateral engine, it was possible to understand that longevity is what characterises the PANORAMIC range. Over the years, its unique design and construction architecture created by Merlo, has been a source of inspiration for many manufacturers.

The Panoramic range has been constantly enhanced, thanks to the use of exclusive technologies, quality materials and the introduction of safety systems, which are essential in order to offer our customers adequate protection and easy operation.



# Precision and ease of use

The stabilised telehandler range is equipped with front supporting feet, designed to ensure greater stability and safety when handling of loads at great heights, guaranteeing operations in all types of construction sites.

- Frame equipped with independent control stabilizers
- Lift capacity up to 5,000 Kg
- Lift height up to 18 m
- Merlo interface for use with over 40 attachments.

## USER INTERFACE:

In-cab display for viewing all the operating parameters. Ergonomic Joystick controls with integrated travel-direction selector switch. Cursors and controls are designed to maximise ease of implementation.

## POWERTRAIN:

Hydrostatic transmission with permanent four-wheel drive, 75 to 143 HP engines and maximum speed of 40 km/h. Exclusive position of the side and longitudinal engine.

## BOOM SIDE-SHIFT:

Load positioning correction device without the need to move the machine, nor alter balance and safety of the operator. Unique on the market.

## TELESCOPIC BOOM:

Heights from 10 to 18 metres with load-bearing capacities from 3,000 to 5,000 kg.

Exclusive design that ensures lightness, precision and durability. Implement-holder carriage equipped with hydraulic Tac-lock locking system, controllable from the cab.

## CAB:

FOPS (Level II) and ROPS certified. The cab is designed to maintain the maximum level of ergonomics while ensuring excellent protection for the operator. The 1010 mm width and the wide glass surface ensure unparalleled comfort and full visibility.

## HYDRAULIC SYSTEM:

Sized hydraulic system to minimise manoeuvring times. Variable displacement (Load Sensing) hydraulic pump for maximum efficiency, excellent performance, and perfectly smooth operation.





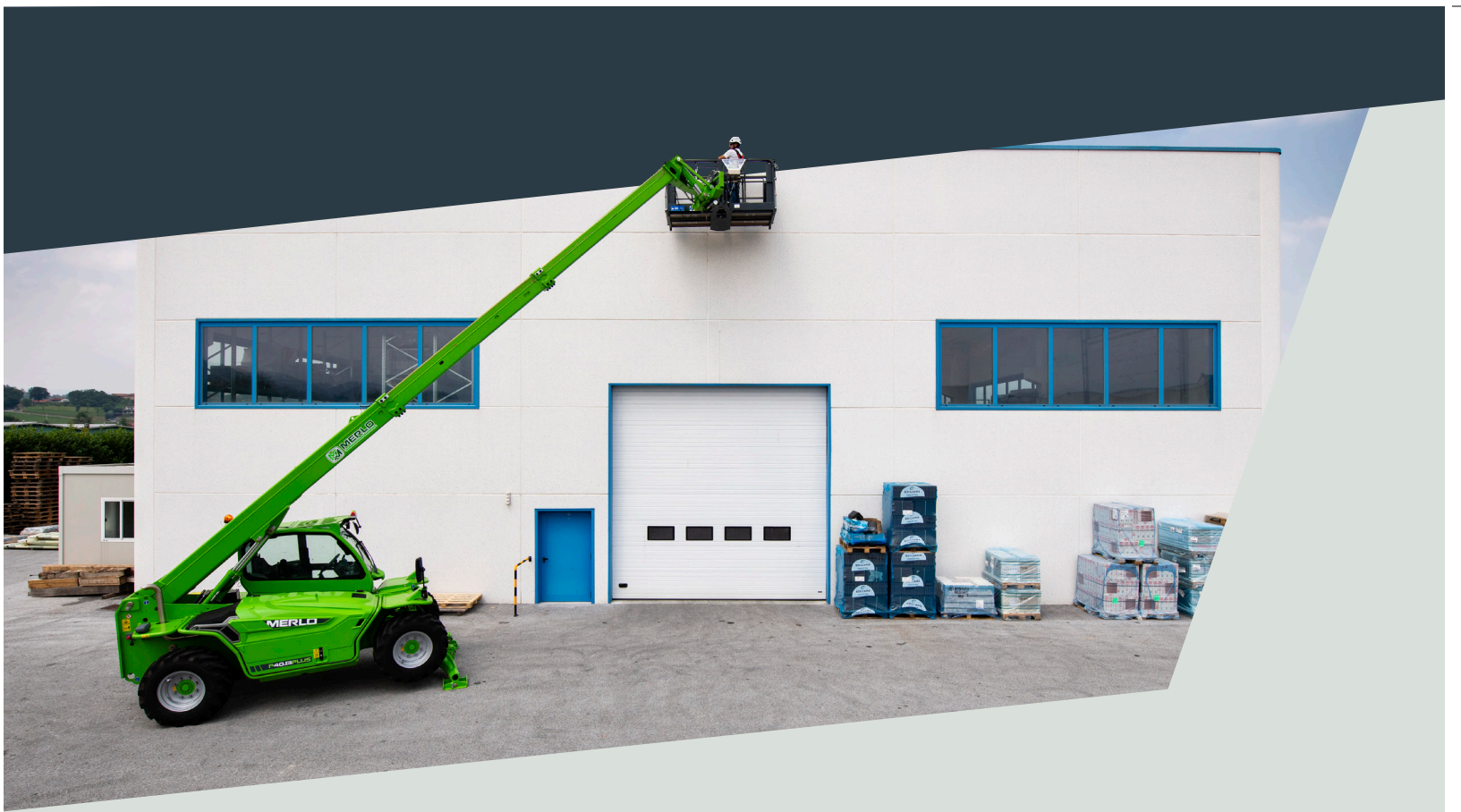

## SAFETY

The exclusive Merlo cab is compliant with the ISO 3449 FOPS (Level II) and ISO 3471 ROPS standards, thus ensuring category-leading safety levels.

Merlo's patented ASCS (Adaptive Stability Control System) is capable of recognising the attachment being used as well as measuring the magnitude of the load being handled, ensuring operators' safety. Through the digital display, customers can check all the operating parameters within which the safety system will intervene by slowing down and stopping any problematic movements. Depending on the implement in use, the system is able to vary the response of the machine and the speed of movements. Machine safety is enhanced by an automatic parking brake management system, which brakes the machine if the engine switches off in order to avoid unintentional movements.



### MERLO BOOM

Boom consisting of a double "C" profile in high-strength steel with welds made along the neutral bending axis. Hydraulic hoses and electrical wires positioned inside the boom with a "cartridge" system, to protect against any possible impacts and easy extraction in case of maintenance. The L-shaped runner blocks are made of composite material to maximise efficiency and reduce impact and wear on the sliding surfaces. The Merlo boom solution can offer:

- High accuracy with millimetric precision of movement control
- No bending of the structure
- Protection of the components and hoses against impacts



## FOPS PROTECTION

A metallic structure, positioned above the glass roof, makes it possible to achieve the most stringent level of certification in terms of protection: FOPS level II. This certification guarantees:

- Perfect comfort in the cab
- Excellent visibility of the load
- Maximum operator safety
- Possibility to easily disassemble the structure for a deeper cleaning of the roof



## LEVELLING

The stabilized telehandlers, apart from the P30.10, are equipped with levelling corrector. This solution is made with two hydraulic cylinders positioned between the frame and the axle, and is able to absorb the transverse inclinations of the ground up to 8%. This ensures a vertical lifting of the load and minimises the risks of lateral instability of the machine.



## FRAME

Compared to market standards, the frame is characterised by small dimensions, allowing to minimise the overall floor space occupied by the machine. Furthermore, it is equipped, on the outside, with an exclusive steel belt (made from a steel section bar).

Designed to maximise structural strength and ensure excellent torsional strength, the underside of the body is completely secured by steel sheets, in order to protect all components from possible impacts during off-road driving.

## MOVEMENT MANAGEMENT

In order to ensure maximum operational safety whilst handling different tools, the stabilized telehandlers are equipped with cursors that inhibit some hydraulic functions, thus avoiding unintentional operation. For example, if using a winch, it is possible to block the rotation of the carriage by keeping the implement cable at the right angles.



★  
UNIQUE  
ON THE  
MARKET  
★





## ASCS

The ASCS (Adaptive Stability Control System) safety system ensures perfect risk prevention of the machine tipping over frontally when handling a load. The system regulates the speed and maximum degree of movement according to three operating parameters:

- Handled load: Kg of material lifted
- Load position: reach, boom extension and carriage rotation
- Implement in use: automatically recognised by the ASCS system.

When the operational stability limit is reached, the system first reduces the speed of the arm and then stops movement completely. All movements towards a position under safer conditions are permitted during this phase. This simplifies the use of the machine even for less experienced users.

### DISPLAY

The ASCS can be optionally equipped with a 10.1" colour display (standard on Plus models) that allows the operator to view all operating parameters in real time. The high-brightness display has an integrated sensor for automatic adjustment according to external light conditions. In this way, a simple reading of the stability conditions is always ensured, shown in a load diagram that updates, in real time, according to the load being handled and the implement in use. At any time the customer can see at what point the safety system will be triggered. Independent control of each hydraulic movement allows the identification of potentially unsafe situations in the event of an ASCS intervention. In these situations, a pop-up message shows the customer all the movements allowed which are not detrimental to the stability of the vehicle. Finally, the display continuously shows the inclinometer to maximise the safe use of the machine.

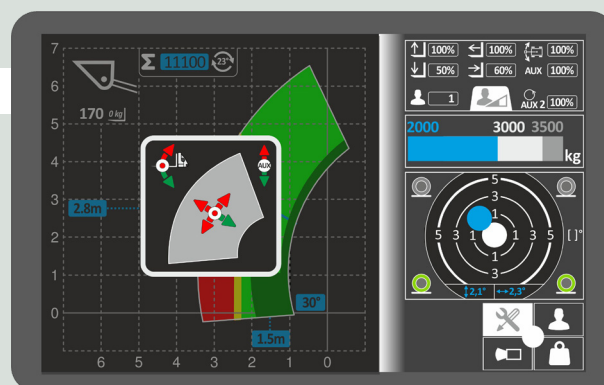



## WORKING AREA SETTING

A special function, accessible via the display, allows the operator to set the geometric working limits. Adjustment can be made either in accordance with the Cartesian axes (maximum and minimum height and extension) or in accordance with the relative movements of the arm (maximum and minimum lift and extension). This solution makes it possible to simplify and increase safety during repetitive work and operations in confined spaces, such as inside a warehouse.

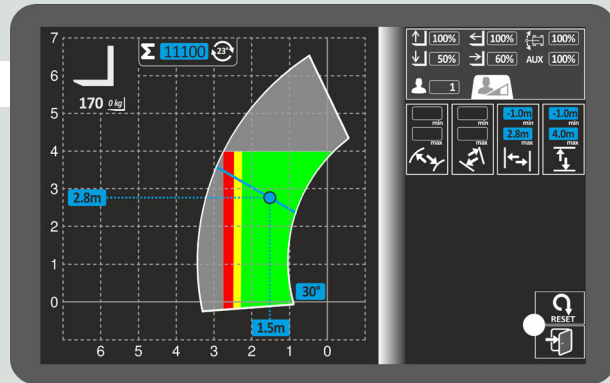

## MOVEMENT SPEED SETTING

The ASCS system uses the display to customise the speed of individual movements of the telescopic boom and the attachments in use according to the needs of individual operators as well as the operations to be carried out. Up to nine different setups can be stored.

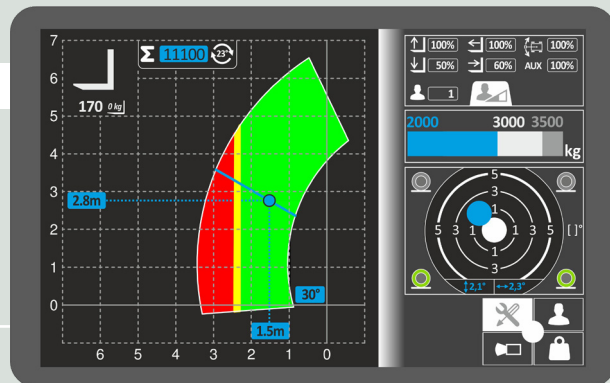

## FREE ZONE

By equipping the machine with a shovel, which is recognised accordingly, the working free zone is automatically activated. A working area of up to 1 metre of reach and 10° of lift. Within this area it is possible to operate without the control system blocking the movement of the implement in case of overload, facilitating digging operations and ensuring perfectly smooth movements.

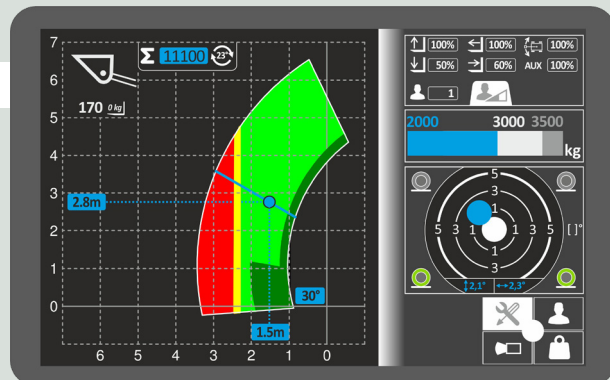

## MEMORISING HANDLED LOADS

Depending on the model, the ASCS display allows the reading of the load being handled, either manually or automatically, whenever the telescopic boom is raised beyond the degrees of inclination pre-set by the operator. The average tolerance on the measured values is  $\pm 5\%$  because these can vary depending on the dynamic conditions of the machine. The system can store up to 1,000 different readings, displaying the total and the last 20 values.

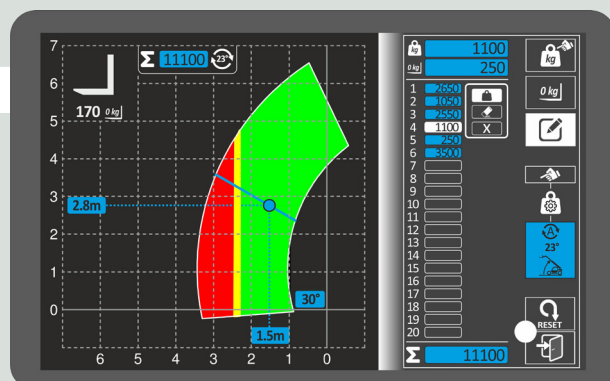





## PERFORMANCE

Merlo telehandlers are equipped with the latest generation of electronically controlled hydrostatic transmission, which, combined with the four-wheel drive that is always engaged, ensures:

- Excellent braking capacity when the accelerator is released
- High levels of power and torque to the wheels
- Unparalleled ease of use

To complete the transmission, all models are equipped with a two-speed mechanical gearbox. This allows them to reach a maximum speed of 40 km/h, without compromising precision of movement, ensured by millimetric adjustment of any movements performed.

### ENGINES

These models feature engines with power ratings ranging from 75 to 143 HP, which, in accordance with the original Merlo design concept, are installed in a longitudinal direction on the right side of the frame. This ensures maximum accessibility to the components during scheduled and/or extraordinary maintenance operations.

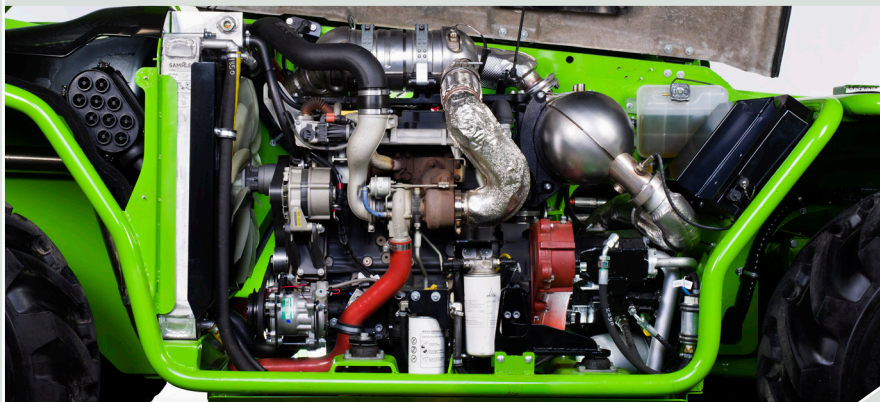

### HYDRAULIC SYSTEM

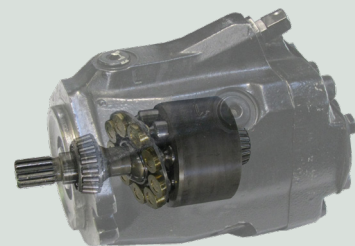

The only models on the market equipped with two separate circuits for Hydraulics and Hydrostatics. The hydraulic circuit consists of a load sensing variable displacement pump to guarantee ease of use and perform up to three simultaneous movements without difficulty.

The hydraulic distributor is mounted to the rear of the frame to reduce vibrations and heat transfer to the cab. At the same time, it increases accessibility for maintenance.



## BOOM SIDE-SHIFT

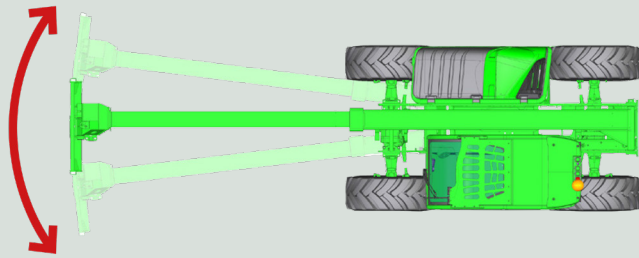

This system is built into the machines' frame, and allows for the lateral movement of the telescopic boom to ensure precise load positioning, with no need for additional manoeuvring, thereby saving time, reducing stress, and improving the machine's productivity.

## RRM

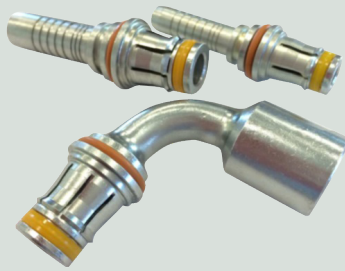

A unique and patented solution. The hydraulic couplings developed and manufactured by Merlo ensure: Quick assembly and disassembly

- Increased tightness of connections
- Increased component service life

## AXLES AND BRAKES

The axles, manufactured in-house by the Merlo Group, are available in two versions: axles with epicyclic reducers, to maximise machine compactness, and axles with portal reducers, to increase ground clearance. Both versions are equipped with four downsized dry disc brakes to ensure high braking capacity and a high level of efficiency that minimises machine consumption. All bearings and bushings are designed to ensure a longer service life and reduce the need for maintenance.

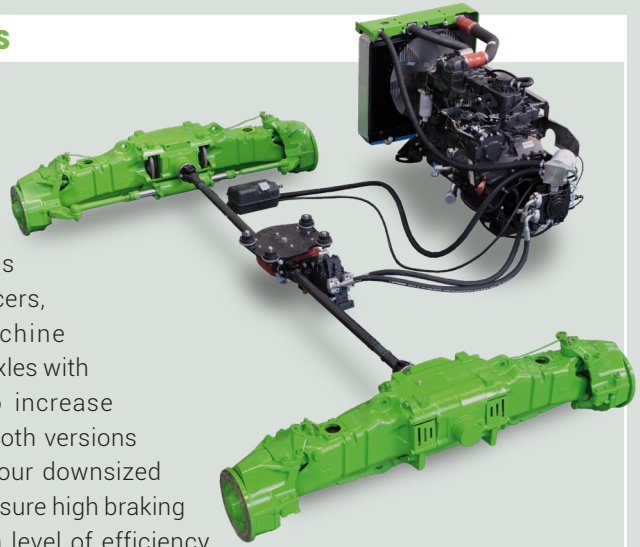

## AERIAL WORK PLATFORM

All stabilized models can be configured with aerial work platform. This solution assures an increased level of active and passive safety during work at heights, and enhances machine versatility.



## FAN DRIVE

The Fan Drive is a technology that allows you to change the engine fan's rotation direction from venting, which cools the radiators, to blowing, which cleans the radiators. It also eliminates dust and residues collected during the work phase, while maintaining the system's performance and efficiency unaltered.







## COMFORT

Acoustic and thermal comfort has also been taken care of down to the smallest details, thanks to intensive research into the most innovative technical solutions and materials. In terms of environmental performance, the entry of dust into the passenger compartment is prevented thanks to the cab's ISO 10263-3 compliant pressurisation\*

The Merlo cab is also an extremely comfortable and practical workplace, thanks to the following features:

- 1,010 mm of width and excellent roominess
- Large glass surface of 4.3 sq. m
- Vibration-damping Silent-blocks, which reduce noise and vibrations

The set-up is complete with a fabric seat with mechanical suspension. Optionally, the machine can be equipped with air-suspension, raised-back and heated seats.



NOTES:

\* pressurisation level not approved for use of pesticides, work in hazardous environments, with asbestos, etc.

### CAB



An unprecedented design guarantees maximum functionality and comfort; the information provided to the driver and the controls of the various systems and devices are grouped for optimal ergonomics. The reverse shuttle on the steering wheel is also present on the Joystick.

- 1 ASCS display
- 2 Capacitive joystick
- 3 Steering wheel and transmission controls
- 4 Transmission display
- 5 Pedal control unit
- 6 Accessory compartment and air conditioning controls



## CAB ENTRY



Easy access to the cab is ensured by the 180° opening door, which maximises entry space, and the large distance between the upright and steering wheel. The side window, which is independent of the door body, can be locked in the open position to maximise air exchange, visibility and direct contact with those working outside near the machine.

## AIR-CONDITIONING

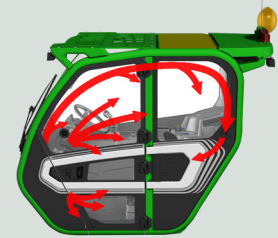

Developed according to automotive standards, cutting the warm-up and cool-down times in half compared to a conventional air conditioning system. The intake opening is located on the side of the cab, away from any potential sources of dust and dirt. Inside there are 8 vents, three of which are dedicated to defrosting the windscreen, for optimal climate comfort.

## BOOM SUSPENSIONS



The active boom suspension system (BSS) is available as an option, which protects the load during transfer and maintains a high level of driving comfort on rough terrain. The suspension is automatically deactivated at low speed (below 3 km/h), for boom maximum precision and power.

## THE MERLO CARRIAGE



Merlo machines have a carriage that is designed to offer maximum performance in terms of excavation and protection of the main parts, all without compromising on lightness, which is essential for ensuring an exceptional lifting capacity. The maximum rotation greatly facilitates the loading and unloading of material with shovels. The Tac-lock device, which comes standard on all the models, guarantees maximum operating comfort by allowing the implements to be hydraulically locked directly from the cab.



### CAPACITIVE JOYSTICK



All telehandlers in this range are equipped with the innovative capacitive electronic joystick control. This instrument is able to detect the presence of the operator's hand by means of a capacitive type sensor, avoiding the use of a special physical control ("dead man" button) in order to enable the hydraulic movements of the machine. With the joystick it is possible to control all the main hydraulic movements of the machine and implements, with up to 4 independent hydraulic movements on the implement as standard.

### CONTINUOUS DELIVERY

The machines can be optionally equipped with a system for regulating and delivering a constant flow of oil to the implements. This solution allows the oil flow to be precisely and specifically adjusted from 0 to maximum flow rate at each of the 4 auxiliary hydraulic outlets at the top of the boom.

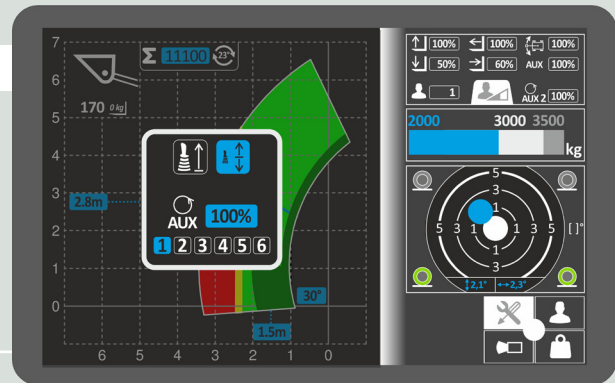

### REAR CAMERA



In combination with the 10.1" colour display of the ASCS system, it is possible to equip the machine with an automatically-operated rear camera, when the reverse gear control is engaged. Images from the rear of the telehandler are shown directly on the in-cab display.

The camera can also be activated manually from the ASCS menu.



## LIGHTING



Merlo telehandlers are all fitted as standard with road lights and a rear number plate lighting system. In addition, the range is equipped, as standard, with additional front and rear lights mounted in the upper part of the cab. This solution allows an optimal view of the area in which work is being performed, even in limited light conditions. Finally, optional boom-mounted lights are available to illuminate the load at every stage of lifting.

## WINDSCREEN WIPERS



The Merlo cab is equipped with three window cleaning wipers as standard. A front one, for cleaning the windscreen, which can be operated at two speeds depending on the volume of rain. An upper one for cleaning the glass roof and a rear one for cleaning the rear window.





## EFFICIENCY

Merlo telehandlers are the most compact and lightweight models on the market. Excellent manoeuvrability is ensured by the 4-wheel steering system and the three steering modes, able to reduce manoeuvring times for decreased fuel consumption.

- Less space manoeuvring needed
- Greater productivity
- Less impact on the ground and less fuel consumption

In order to ensure efficient management of the attachments, all the models feature a double-acting hydraulic service line and an electrical socket for machine-implement communication located at the top of the boom.



### BATTERY SWITCH



As a standard feature, the telehandlers in this range come equipped with an electric and automatic battery switch to improve the efficiency and life of the batteries. Removing the key from the ignition switch starts the process of disconnecting the machine's

electrical circuit.

With the circuit off, simply insert the keys into the control panel again to reactivate the batteries.

### THREE STEERING WAYS

This exclusive solution adopted on the axles guarantees the maximum steering angle to perform manoeuvres in tight spaces.



front wheel steering



pivot steering

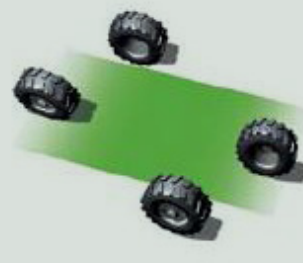

crab steering

### VISIBILITY



The improved visibility on the market ensures efficiency in movement and safety for customers, reducing stress for operators who perform numerous manoeuvres during the working day. A careful study of the positioning of the cab and boom, as well as a detailed bonnet design and a large glass surface, ensure fast, safe and precise operations.

### STABILIZERS

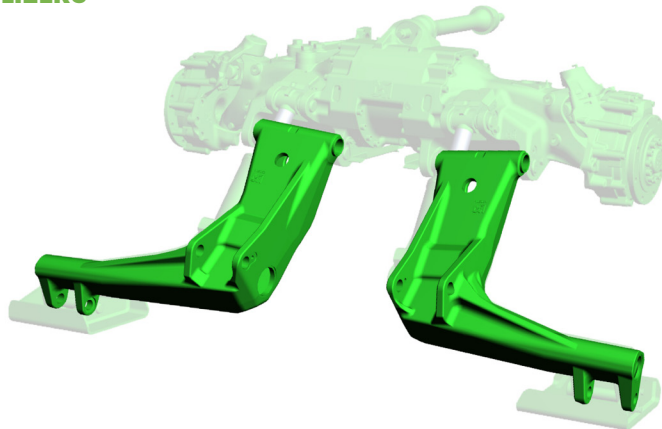

The stabilizers are simply structured to optimise fast and safe installation. The exclusive design of the stabilizers, always in shape, offers high structural strength. This ensures limited footprint during operations, as well as high visibility when driving. The independent control allows the single operation of each stabilizer, enabling a simpler positioning on the ground. Furthermore, the shape of the supporting foot guarantees excellent anchoring to the ground even on soft or steep terrain.



### EPD AND AUTO-REVING JOYSTICK

#### REDUCED CONSUMPTION Merlo EPD technology

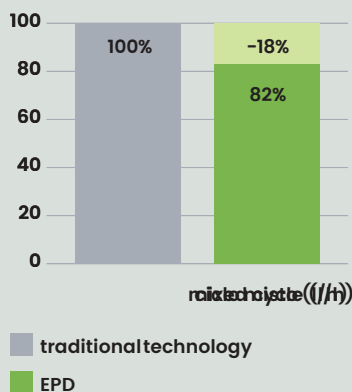

The exclusive and innovative EPD (Eco Power Drive) transmission and engine control system. The EPD controls and adjusts the engine speed based on the operating conditions, for a reduction in fuel consumption of up to 18%. enabling savings of up to 3,300 €/year (the figure assumes an average use of 1,000 h/year and an average fuel price of 1.1 €/l). Finally, the EPD provides for the control of the engine speed proportionally to the use of the joystick (the greater the inclination of the joystick, the greater the engine revolutions). This feature

further optimises machine consumption, allowing idle speed to be maintained for longer while maximising responsiveness for material handling.





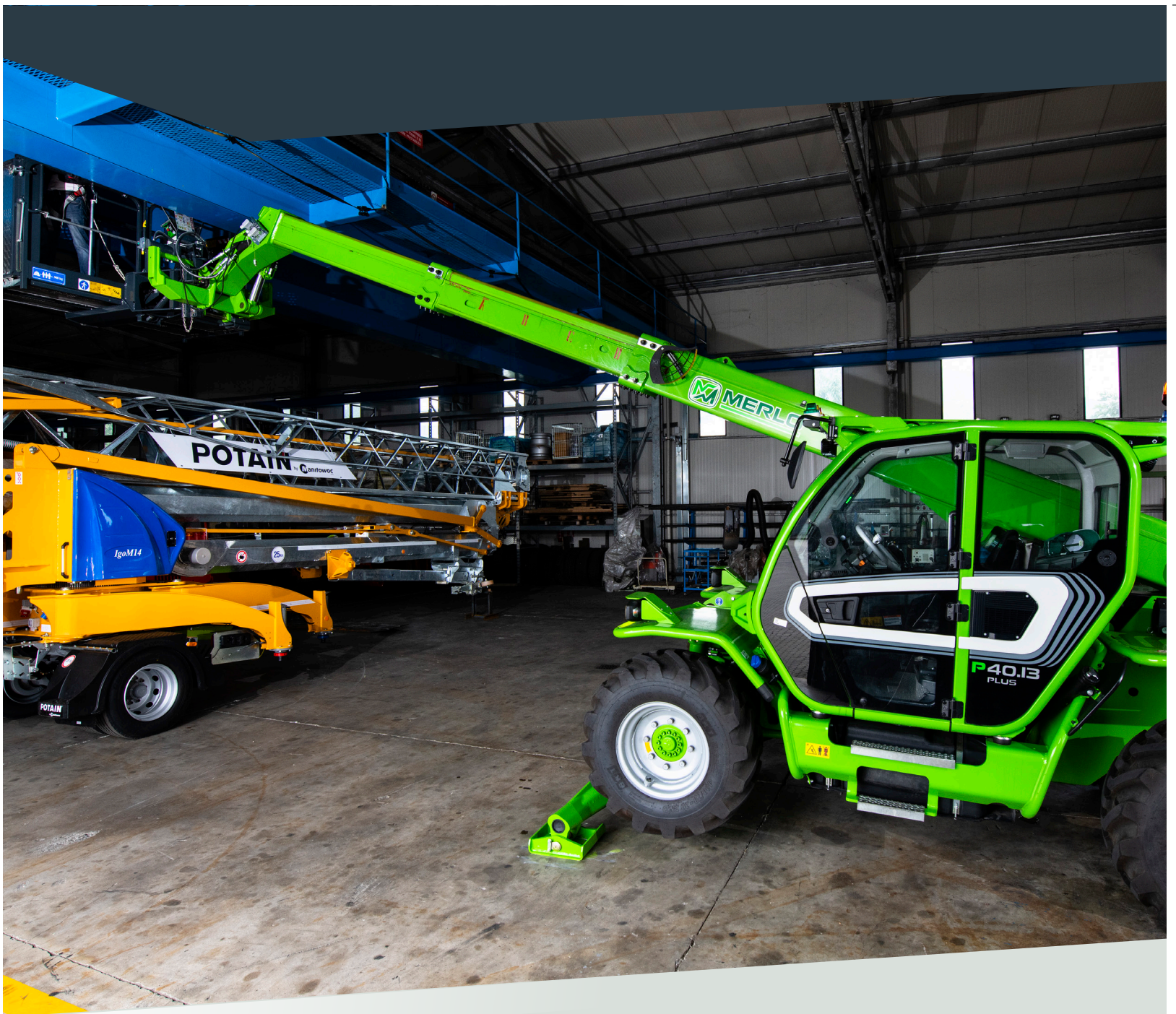

## STABILIZED TELEHANDLER RANGE

The stabilized telehandler models are developed to meet the specific needs of customers operating in the industrial, construction, and infrastructure sectors. The range great versatility allows us to offer models featuring compact dimensions (suitable for confined construction sites), as well as models with high flow rates and lift heights, able to provide solutions even in very large construction sites. Merlo models can be offered in two versions that differ in their technical and configuration characteristics.





### • **ENTRY** Version

The ENTRY models are easy to use and feature a simple interface. Developed to meet the needs of every construction site, as well as rental and large construction companies, they guarantee exceptional performance and economic efficiency.

These models' most salient features include:

- Precise and powerful hydraulics with Load Sensing technology
- EPD transmission with maximum speed of 33 km/h
- 55 kW/ 75HP heat engine



### • **PLUS** Version

The PLUS models have been developed to offer the highest level of technology in terms of efficiency, performance and versatility of use to serve the most demanding operators. These models are all equipped with the ASCS digital display to optimise the information reported to the customer.

These models' most salient features include:

- Precise and powerful hydraulics with Load Sensing technology
- EPD transmission with maximum speed of 40 km/h
- 85,9kW/116HP heat engine





# ATTACHMENTS

The attachments, which are designed and manufactured at the Merlo Group facilities, are the real operational tools used by Merlo telehandlers, and are designed to bring out the machines' performance and versatility in different operational situations.

The patented recognition of the attachments and the effective Tac-lock hydraulic locking system allow for quick tool changes to be performed, with the operating parameters being configured automatically for maximum safety.

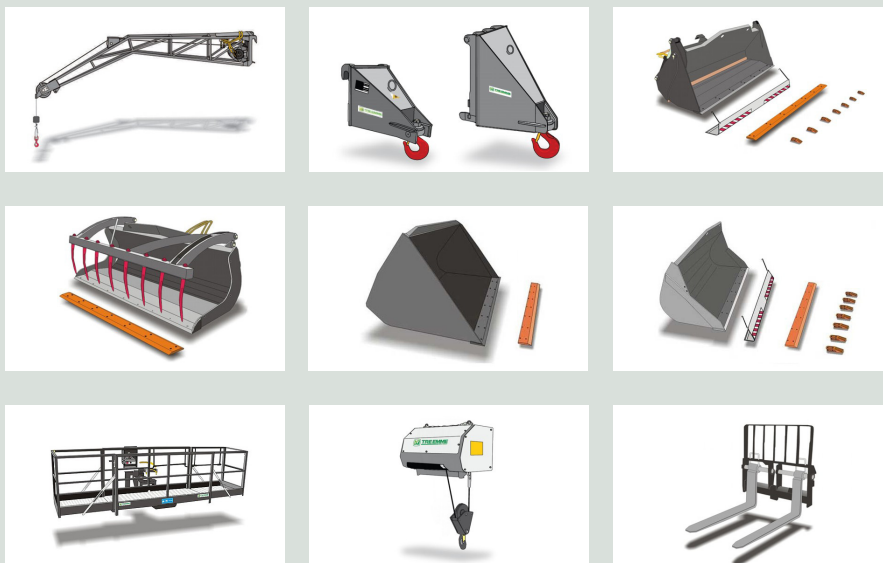

# SERVICE & PARTS

Whoever buys a Merlo machine chooses a product that meets the highest standards of quality, reliability and innovation. The customer can count on first-rate support and maintenance services offered by the Merlo Service network, and original spare parts subjected to continuous and rigorous quality controls.

Careful and periodic maintenance, combined with the use of original spare parts, will help your telehandler maintain its performance levels over time.



# MERLOMOBILITY

The Merlo telehandler range offers exclusive technology, making their telehandlers even smarter and more connected.

The MerloMobility 4.0 connectivity system allows the customer to make use of all the information collected by the machines and transferred to the dedicated portal. Merlo Mobility is a flexible tool that allows the user to optimise the operational monitoring of their machines used in various sectors. The MerloMobility system is available as an option on all other Merlo models.



# Technical characteristics

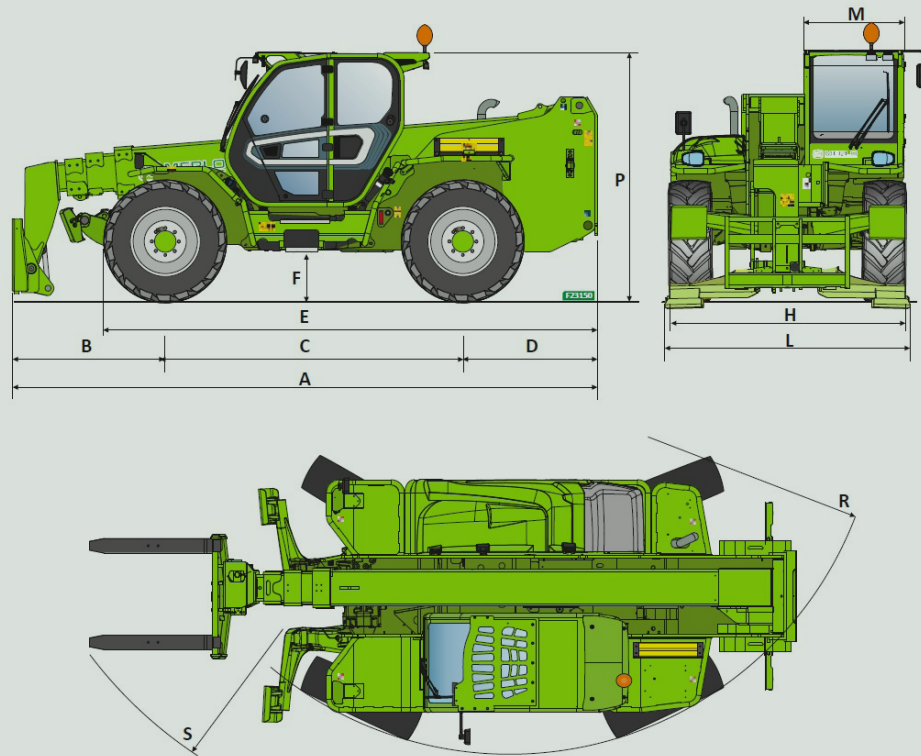

	Dimensions	A	B	C	D	E	F	H	L	M	P	R	S	T	Z
<b>P30.10</b>	mm	4700	1360	2740	600	3910	290	2100	2200	995	2120	3930	5050	4150	850
<b>P35.11</b>	mm	5150	1634	2810	705	4104	460	2310	2380	995	2530	3985	5200	4535	850
<b>P40.12</b>	mm	5010	1290	2810	910	4260	375	2240	2380	1010	2425	3920	4900	4450	850
<b>P40.12 Plus</b>	mm	5010	1290	2810	910	4260	375	2240	2380	1010	2425	3920	4900	4450	850
<b>P40.13</b>	mm	5410	1690	2810	910	4260	375	2240	2380	1010	2425	3920	4940	4400	850
<b>P40.13 Plus</b>	mm	5410	1690	2810	910	4260	375	2240	2380	1010	2425	3920	4940	4500	850
<b>P40.14</b>	mm	5750	1645	2810	1295	4640	375	2240	2380	1010	2425	3920	5040	4450	850
<b>P40.14 Plus</b>	mm	5750	1645	2810	1295	4640	375	2240	2380	1010	2425	3920	5040	4450	850
<b>P40.17</b>	mm	5970	1705	2950	1315	4852	450	2420	2550	1010	2500	4050	5160	4550	850
<b>P40.17 Plus</b>	mm	5970	1705	2950	1315	4852	450	2420	2550	1010	2500	4050	5160	4550	850
<b>P50.18 Plus</b>	mm	6190	1745	3060	1385	5067	485	2480	2550	1010	2535	4265	5611	4845	850



Model	P30.10	P35.11	P40.12	P40.12 PLUS	P40.13	P40.13 PLUS	P40.14	P40.14 PLUS	P40.17	P40.17 PLUS	P50.18 PLUS
<b>Performance</b>											
Unladen weight (kg)	7600	9000	9200	9200	9300	9300	9950	9950	11670	11670	13300
Maximum load capacity (kg)	3000	3500	4000	4000	4000	4000	4000	4000	4000	4000	5000
Lift height (m)	9.6	11	11.5	11.5	12.5	12.5	13.5	13.5	16.6	16.6	17.5
Maximum reach (m)	6.5	7.8	7.63	7.63	8.74	8.74	9.3	9.3	12.47	12.47	13.5
Reach at max. load capacity (m)	2.3	2	3.4	3.4	3.3	3.3	3,5	3,5	4.06	4.06	3.7
Load capacity at max. reach (kg)	1000	1000	1300	1300	1000	1000	1000	1000	600	600	750
Boom side-shift (mm)	-	+/- 310	+/- 330	+/- 330	+/- 340	+/- 340	+/- 345	+/- 345	+/- 435	+/- 435	+/- 445
Frame levelling (%)	-	+/- 8	+/- 8	+/- 8	+/- 8	+/- 8	+/- 8	+/- 8	+/- 8	+/- 8	+/- 8
<b>Powertrain</b>											
Engine	Kohler 2504 TCR	Kohler 2504 TCR	Kohler KDI2504	Perkins 904J	Kohler KDI2504	Perkins 904J	Kohler KDI2504	Perkins 904J	Kohler KDI2504	Perkins 904J	Perkins 904J
Engine power (kW/HP)	55,4/75,1	55,4/75,1	55,4/75,1	85,9/115	55,4/75,1	85,9/115	55,4/75,1	85,9/115	55,4/75,1	85,9/115	85,9/115
Anti-pollution technology	Stage V DOC+DPF	Stage V DOC+DPF	Stage V DOC+DPF	Stage V SCR+DPF +DOC	Stage V DOC+DPF	Stage V SCR+DPF +DOC	Stage V DOC+DPF	Stage V SCR+DPF +DOC	Stage V DOC+DPF	Stage V SCR+DPF +DOC	Stage V SCR+DPF +DOC
Maximum speed (km/h)	40	33	33	40	33	40	33	40	33	40	40
Fuel tank capacity (l)	80	140	140	140	140	140	140	140	140	140	140
Adblue tank capacity (l)	-	-	-	18	-	18	-	18	-	18	18
Hydrostatic transmission	2 Speed	2 Speed	2 Speed	2 Speed	2 Speed	2 Speed	2 Speed	2 Speed	2 Speed	2 Speed	2 Speed
EPD	STD	STD	STD	STD	STD	STD	STD	STD	STD	STD	STD
<b>Hydraulic system</b>											
Hydraulic pump	LS + FS	LS + FS	LS	LS	LS	LS	LS	LS	LS	LS	LS
Delivery/pressure (l/min-bar)	117-210	117 - 250	104 - 250	104 - 250	104 - 250	104 - 250	104 - 250	104 - 250	104 - 250	104 - 250	104 - 250
Hydraulic oil tank capacity (l)	85	100	100	100	100	100	100	100	100	100	110
<b>Cab</b>											
Cab finishing	SUPERIOR	SUPERIOR	SUPERIOR	SUPERIOR	SUPERIOR	SUPERIOR	SUPERIOR	SUPERIOR	SUPERIOR	SUPERIOR	SUPERIOR
ASCS	Light	Light	Light	Full	Light	Full	Light	Full	Light	Full	Full
FOPS/ROPS Cab	YES	YES	YES	YES	YES	YES	YES	YES	YES	YES	YES
Joystick	Electronic	Electronic	Electronic	Electronic	Electronic	Electronic	Electronic	Electronic	Electronic	Electronic	Electronic
Reverse shuttle	Dual reverse	Dual reverse	Dual reverse	Dual reverse	Dual reverse	Dual reverse	Dual reverse	Dual reverse	Dual reverse	Dual reverse	Dual reverse
<b>Configuration</b>											
Hydropneumatic suspension BSS	OPT	OPT	OPT	OPT	OPT	OPT	OPT	OPT	OPT	OPT	OPT
Tac-lock	YES	YES	YES	YES	YES	YES	YES	YES	YES	YES	YES
Permanent four-wheel drive	YES	YES	YES	YES	YES	YES	YES	YES	YES	YES	YES
4-wheel steering, with three steering modes	YES	YES	YES	YES	YES	YES	YES	YES	YES	YES	YES
Standard tyres	400/70-20	400/70-24	400/70-20	400/70-20	400/70-20	400/70-20	400/70-20	400/70-20	400/70-24	400/70-24	400/80-24
Stabilizers	In stowed position	In stowed position	In stowed position	In stowed position	In stowed position	In stowed position	In stowed position	In stowed position	In stowed position	In stowed position	In stowed position



P30.10

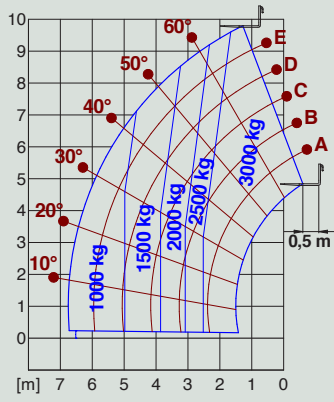

P40.13

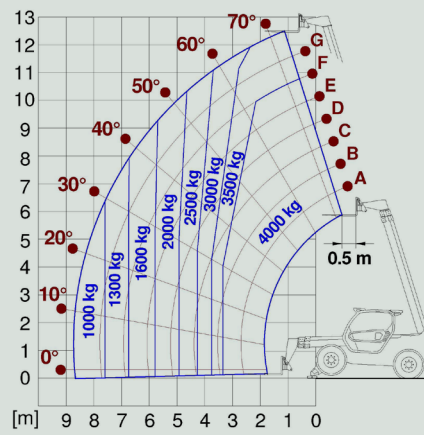

P35.11

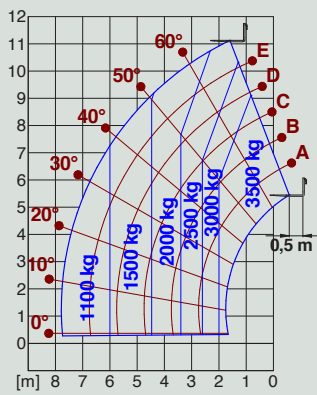

P40.14

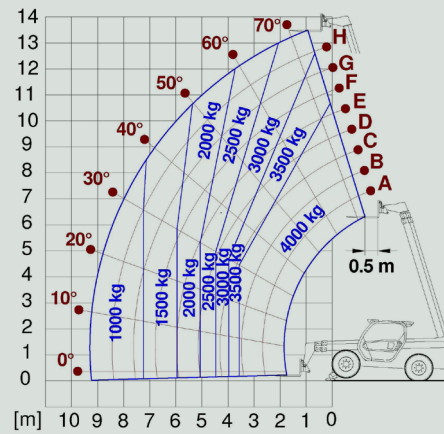

P40.12

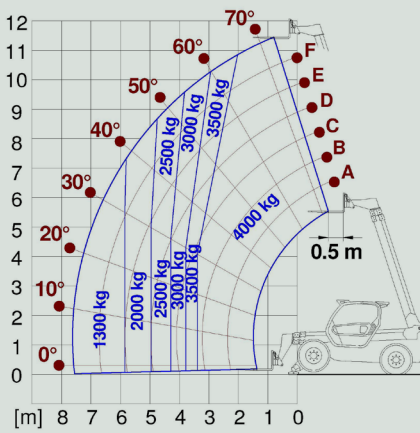

P40.17

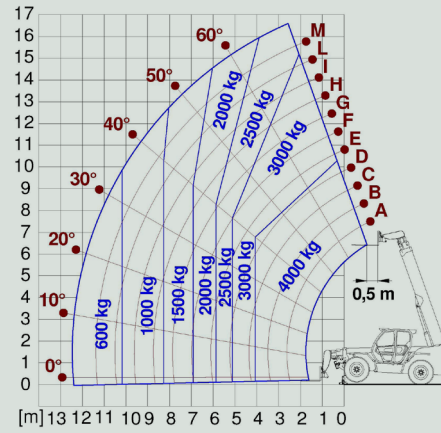

P50.18

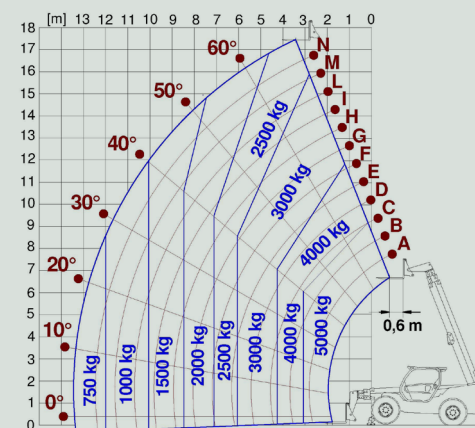





**MERLO S.P.A.**

Via Nazionale, 9 - 12010 S. Defendente di Cervasca - Cuneo - Italia  
Tel. +39 0171 614111 - Fax +39 0171 684101  
[www.merlo.com](http://www.merlo.com) - [info@merlo.com](mailto:info@merlo.com)

**Your Merlo dealer**

Data, characteristics and illustrations contained in this document are indicative and not binding.  
Merlo Spa pursues a policy of continuous research and development, therefore, our products may have different characteristics from those described or may undergo changes without any prior notice.  
The products shown may include optional equipment.